

LED WATTAGE CHART

	16L
175 milliamps	10w (765-850 Lumens)
400 milliamps	21w (2158-2581 Lumens)
530 milliamps	28w (2940-3584 Lumens)
700 milliamps	36w (3636-4428 Lumens)
1050 milliamps	56w (5408-6496 Lumens)

Form

- Elegant Rectilinear Extruded Aluminum Housing
- Corrosion Resistant Stainless Steel External Hardware
- Sleek, Low Profile Housing
- Spec Grade Performance
- Engineered For Optimum Thermal Management
- Anchor Base Plate For Easy Installation
- 9 Architectural Finishes Standard, RAL Colors Available

Function

- Micro Optics IES Distributions T2, T3, T4
- 0-10V Dimming Drivers THD @ Max Load < 15% Power Factor @ Max Load < 0.95
- Amber, 2700K, 3000K, 3500K, 4000K, or 5000K
- 16L LED Configuration
- 10-56 Watts (Single Head Wattage)
- CRI 70, 80, or 90
- Extruded Aluminum Heat Sink
- 5 Mils Powder Coat

Reliability

- Silicone Micro Optics
- 5 Year Standard Warranty
- IP67 Optics
- Reduces Energy Consumption And Costs Up To 65%

BUY AMERICAN

To ensure the latest BAA/TAA/BABA Standards are being met, please select BAA, TAA, or BABA in the options section. Please contact the factory before placing an order for any NLS products requesting BAA (Buy American Act), TAA (Trade American Act), or BABA (Build America, Buy America).



Project Name:

Type:

TBL ORDERING GUIDE

Cat#	Length	Light Dist.	No. of LEDs	Milliamps
Trac Linear Bollard (TBL)	24 in (24)	Type 2 (T2)	16 (16L)	175 (175)
	36 in (36)	Type 3 (T3)		400 (40)
	42 in (42)	Type 4 (T4)		530 (53)
				700 (7)
				1050 (1)
Kelvin	Volts	Mounting	Color	Options
Amber 585-600nm (AMBER) ^①	120-277 (UNV)	Anchor Base (AB)	Bronze Textured (BRZ)	Marine Grade Finish (MGF)
2700K, 70 CRI (27K7)			White Textured (WHT)	Dual Head (DH)
2700K, 80 CRI (27K8) ^①			Smooth White Gloss (SWT)	House Side Shield (HSS)
3000K, 70 CRI (30K7)			Silver Textured (SVR)	20KA Surge Protector (20KA)
3000K, 80 CRI (30K8) ^①			Black Textured (BLK)	Buy American (BAA) ^④
3500K, 80 CRI (35K8)			Smooth Black Gloss (SBK)	Trade American (TAA) ^④
4000K, 70 CRI (40K7)			Graphite Textured (GPH)	Build America Buy American (BABA) ^④
4000K, 80 CRI (40K8) ^①			Grey (GRY)	Custom Controls Integration (CCI) ^②
5000K, 70 CRI (50K7)			Green (GRN)	
5000K, 80 CRI (50K8) ^①			Custom (CS)	

Notes:

- ① Consult Factory for Lead Time. Consult Factory for 90 CRI Requests.
- ② Please contact Factory for Custom Control Integration requests (nLight, NX, WaveLinX, Crestron, DMX/RDM, Synapse, Casambi, Dali II, Avi-On, or other control systems)
- ③ Turtle Safe
- ④ Consult factory for all BAA/TAA/BABA requests

PRODUCT SPECIFICATIONS

ELECTRICAL

- 120-277 Volts (UNV)
- 0-10V dimming driver
- Driver power factor at maximum load is $\geq .95$, THD maximum load is 15%
- LED Drivers Ambient Temp. Min is -40°C and Ambient Temp. Max ranges from 50°C to 55°C and, in some cases, even higher. Consult the factory for revalidation by providing the fixture catalog string before quoting and specifying it.
- All drivers, controls, and sensors housed in enclosed compartment
- CRI 70, 80, or 90
- Color temperatures: Amber, 2700K, 3000K, 3500K, 4000K, or 5000K
- Surge Protection: 20KA optional.

OPTIONS

- MARINE GRADE FINISH (MGF)—A multi-step process creating protective finishing coat against harsh environments. Chemically washed in a 5 stage cleaning system. Pre-baked, Powder coated 3-5 mils of Zinc Rich Super Durable Polyester Primer. Oven Baked. Finished Powder Coating of Super Durable Polyester Powder Coat 3-5 mil thickness.
- DUAL HEAD (DH)
- SHIELD (HSS)—House Side Shield is designed for full property line cut-off.
- 20KA SURGE PROTECTOR (20KA)

CONSTRUCTION

- Extruded Aluminum
- Internal cooling fins
- Corrosion resistant external hardware
- One-piece silicone gasket ensures water tight seal for electronics compartment
- Two-piece silicone Micro Optic system ensures IP67 seal around each PCB
- Controls Agnostic: Please contact factory for your preferred controls option. (nLight, NX, WaveLinx, Crestron, DMX/RDM, Synapse, Casambi, DALI II, Avi-On, or other control systems)

FINISH

- 3-5 mils electrostatic powder coat.
- NLS Lighting standard high-quality finishes prevent corrosion and protects against extreme environmental conditions

WARRANTY

Five-year limited warranty for drivers and LEDs.

OPTICS

Silicone optics high thermal stability and light output provide higher powered LEDs with minimized lumen depreciation. UV stability with scratch resistance increases exterior application durability. Silicone optics do not yellow, crack or brittle over time

LISTINGS

- Certified to UL 1598
- UL 8750
- CSA C22.2 No. 250.0
- IP65/ IP67 Rated
- IK10 Rated

BUY AMERICAN OPTION

While all of the NLS Lighting products listed in this document qualify for the Buy America(n) Act of 1933, we reserve the right to change our listings without notice.

The information provided above is for general informational purposes only. We encourage you to consult legal professionals for advice particular to your projects concerning BAA, TAA, BABA or Buy America.

Additional NLS Products that meet BAA, TAA standards can be found at the following link:

<https://nslighting.com/buy-american/>



The information and specifications on this document are subject to change without any notification. All values are design, nominal, typical or prorated values when measured under internal and external laboratory conditions.

NLS
LIGHTING

701 Kingshill Place, Carson, CA 90746
P: (310) 341-2037

nslighting.com

PRODUCT SPECIFICATIONS

TBL LUMEN CHART

TRAC LUMEN CHART							
PART NUMBER	T2	LM/W	T3	LM/W	T4	LM/W	WATTS
TBL-16L-175-30K7	774	77	765	77	799	80	10
TBL-16L-175-40K7	799	80	791	79	825	83	10
TBL-16L-175-50K7	833	73	816	82	850	85	10
TBL-16L-40-27K7	2196	105	2209	105	2158	103	21
TBL-16L-40-27K8	2057	98	2069	99	2021	96	21
TBL-16L-40-30K8	2205	105	2218	106	2166	103	21
TBL-16L-40-30K7	2375	113	2389	114	2333	111	21
TBL-16L-40-35K8	2205	105	2218	106	2166	103	21
TBL-16L-40-40K8	2375	113	2389	114	2333	111	21
TBL-16L-40-40K7	2566	122	2581	123	2521	120	21
TBL-16L-40-50K8	2375	113	2389	114	2333	111	21
TBL-16L-40-50K7	2566	122	2581	123	2521	120	21
TBL-16L-53-30K7	2968	106	2940	105	3080	110	28
TBL-16L-53-40K7	3220	115	3192	114	3332	119	28
TBL-16L-53-50K7	3472	124	3416	122	3584	128	28
TBL-16L-7-30K7	3672	102	3636	101	3816	106	36
TBL-16L-7-40K7	3996	111	3924	109	4104	114	36
TBL-16L-7-50K7	4284	119	4248	118	4428	123	36
TBL-16L-1-30K7	5544	99	5488	98	5408	96	56
TBL-16L-1-40K7	6048	108	5936	106	5992	107	56
TBL-16L-1-50K7	6496	116	6384	114	6440	115	56

Lumen Maintenance Data							
Ambient Temperature	Drive Current	L90 Hours*	L70 Hours**	30,000 Hours*	50,000 Hours*	60,000 Hours*	100,000 Hours**
25°C	Up to 700mA	58,000	173,000	95.7%	91.6%	89.6%	82.1%
	1050mA	48,000	143,000	94.3%	89.5%	87.2%	78.5%

*Reported extrapolations per IESNA TM-21 **Projected extrapolations per IESNA TM-21

OPTICAL CONFIGURATIONS

Rotatable Optics (ROR) Rotated Right, (ROL) Rotated Left options available. Optics field and factory rotatable.

TBL / 16L

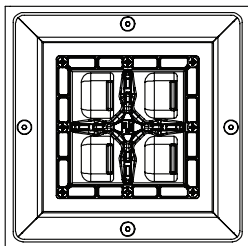

PRODUCT SPECIFICATIONS

IES DISTRIBUTIONS

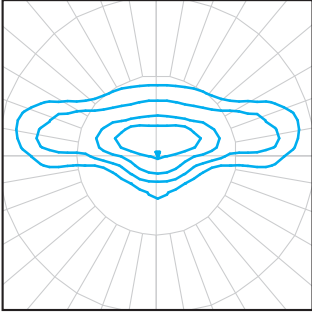

T2 Optic

The Type II distribution is used for narrow pathways and trails, narrow entrances of shopping centers, parking lots and office complex's.

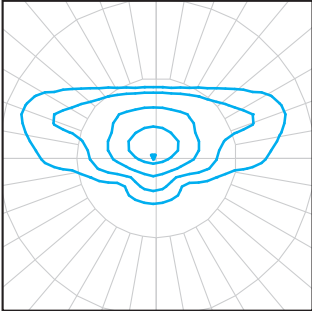

T3 Optic

The type III distribution is meant for roadway lighting, general parking areas and other areas where a larger area of lighting is required. Type III lighting needs to be placed to the side of the area, allowing the light to project outward and fill the area. This produces a filling light flow.

Type III light distributions have a preferred lateral width of 40 degrees. This distribution is intended for luminaires mounted at or near the side of medium width roadways or areas, where the width of the roadway or area does not exceed 2.75 times the mounting height.

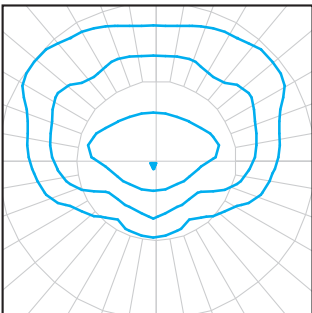

T4 Optic

The type IV distribution produces a semicircular light meant for mounting on the sides of buildings and walls. It's best for illuminating the perimeter of parking areas and businesses. The intensity of the Type IV lighting has the same intensity at angles from 90 degrees to 270 degrees.

Type IV light distributions have a preferred lateral width of 60 degrees. This distribution is intended for side-of-road mounting and is generally used on wide roadways where the roadway width does not exceed 3.7 times the mounting height.

SILICONE OPTICS

NLS Lighting Silicone Micro Optical System technology takes quality and performance to the highest level. Vandal resistant, superior clarity—Micro Optics have become the best and lasting solution in the industry.

BENEFITS

- Produces superior 96% clarity
- Heat resistant to 150° C, 50% higher than acrylic
- Ecologically friendly—no glare
- Vandal-resistant
- Does not brittle, crack, or yellow over time

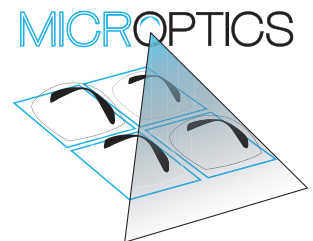

LED KELVIN RANGE

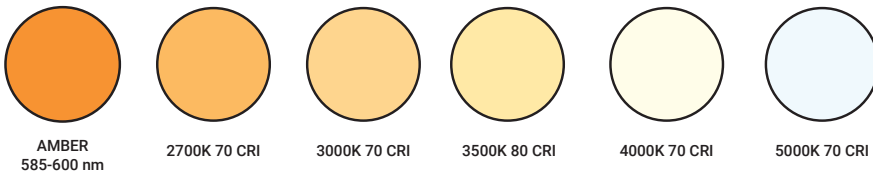

Color	Dominant or Peak Wavelength Range (nm)	
	Minimum	Maximum
Amber	585	600

PRODUCT SPECIFICATIONS

MODEL	WEIGHT
TBL	13.5

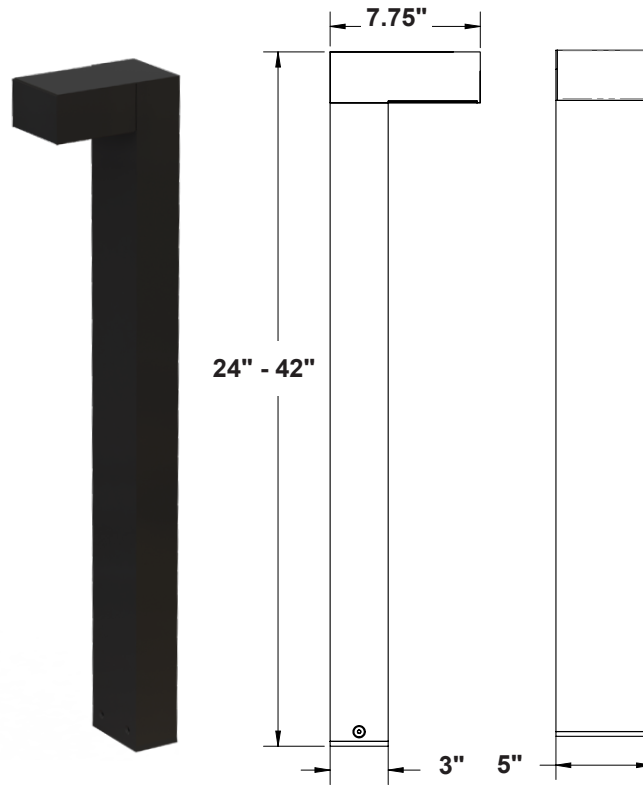

MODEL	WEIGHT
TBL	13.5