

LED WATTAGE CHART

Drive Current	64L
425 milliamps	88W (6358-7428 Lumens)
530 milliamps	103W (9628-11248 Lumens)
600 milliamps	117W (10900-12734 Lumens)
700 milliamps	136W (12717-14856 Lumens)
850 milliamps	175W (14533-16978 Lumens)

Form

- Elegant Die-Cast Aluminum Housing
- Corrosion Resistant Stainless Steel External Hardware
- Sleek, Low Profile Housing
- Spec Grade Performance
- Engineered For Optimum Thermal Management
- 9 Architectural Finishes Standard, RAL Colors Available

Function

- Micro Optics IES Distribution T2
- 0-10V Dimming Drivers
- THD @ Max Load < 15%
- Power factor @ Max Load < 0.95
- Amber, 2700K, 3000K, 3500K, 4000K, or 5000K
- 64L LED Configuration
- CRI 70, 80, or 90
- 5 Mils Powder Coat
- Up to 16978 Lumens

Reliability

- Silicone Micro Optics
- 5 Year Standard Warranty
- IP67 Optics
- IP66 Fixture

BUY AMERICAN

To ensure the latest BAA/TAA/BABA Standards are being met, please select BAA, TAA, or BABA in the options section. Please contact the factory before placing an order for any NLS products requesting BAA (Buy American Act), TAA (Trade American Act), or BABA (Build America, Buy America).



Project Name:

Type:

ORGANIX - CORNER - ORDERING GUIDE

Cat#	Light Dist.	No. of LEDs	Milliamps	Kelvin Temp	Volts
Organix - Corner Mount (ORX-C)	Type 4 Corner (T4C)	64 (64L)	425 (42)	Amber 585-600nm (AMBER) ④⑤⑥	120-277 (UNV)
			530 (53)	2700K, 70 CRI (27K7)	
			600 (60)	2700K, 80 CRI (27K8) ①	
			700 (7)	3000K, 70 CRI (30K7)	
			850 (85)	3000K, 80 CRI (30K8) ①	
				3500K, 80 CRI (35K8)	
				4000K, 70 CRI (40K7)	
				4000K, 80 CRI (40K8) ①	
				5000K, 70 CRI (50K7)	
				5000K, 80 CRI (50K8) ①	

Mounting	Color	Control Options	Options	Lens Options
Corner Mount (BLANK)	Bronze Textured (BRZ)	FSP-211 with Motion Sensor (FSP-8) ③	Marine Grade Finish (MGF)	Diffused Polycarbonate Visual Comfort Lens (DPCL)
Corner Wall Mount (CWM)	White Textured (WHT)	8' and lower Heights (FSP-20) ③	Bird Spikes (BS)	Clear Tempered Glass Lens (CTG)
Conduit Box Wall Mount (CBWM)	Smooth White Gloss (SWT)	9'-20" Heights (FSP-40) ③	House Side Shield (HSS)	
	Silver Textured (SVR)	21'-40' Heights (FSP-40) ③	Tamper Proof Hardware (TPH)	
	Black Textured (BLK)	FSP Remote (FSIR) ⑦	Black Hardware (BH)	
	Smooth Black Gloss (SBK)	Emergency Battery 8w (EM8) ③	Black Optic Frame (BOF)	
	Graphite Textured (GPH)	Nema 7-Pin Receptacle (PE7)	Buy American (BAA) ⑧	
	Grey (GRY)	Custom Controls Integration (CCI) ③	Trade American (TAA) ⑧	
	Green (GRN)		Build America Buy American (BABA) ⑧	
	Custom (CS)			

- Notes:**
- ① Consult Factory For Lead Time. Consult Factory For 90 CRI Requests.
 - ② Universal Voltage 120-277
 - ③ Please contact Factory for Custom Control Integration requests (nLight, NX, WaveLinx, Crestron, DMX/RDM, Synapse, Casambi, Dali II, Avi-On, or other control systems)
 - ④ Turtle Safe
 - ⑤ Consult factory for all BAA/TAA/BABA requests
 - ⑥ Powers 2 LED Modules Only
 - ⑦ Projects with sensors require Qty. 1 FSIR per project.
 - ⑧ Max mA 1050
 - ⑨ Consult Factory



701 Kingshill Place, Carson, CA 90746
P: (310) 341-2037

nslighting.com

PRODUCT SPECIFICATIONS

ELECTRICAL

- 120-277 Volts (UNV)
- 0-10V dimming driver
- Driver power factor at maximum load is $\geq .95$, THD maximum load is 15%
- LED Drivers Ambient Temp. Min is -40°C and Ambient Temp. Max ranges from 50°C to 55°C and, in some cases, even higher. Consult the factory for revalidation by providing the fixture catalog string before quoting and specifying it.
- All drivers, controls, and sensors housed in enclosed IP65 compartment
- CRI 70, 80 or 90
- Color temperatures: Amber, 2700K, 3000K, 3500K, 4000K, 5000K
- Surge Protection: 20KVA supplied as standard.

CONSTRUCTION

- Die Cast Aluminum
- Internal cooling fins
- Corrosion resistant external hardware
- One-piece silicone gasket ensures IP66 seal for electronics compartment

OPTICS

Silicone optics high thermal stability and light output provide higher powered LEDs with minimized lumen depreciation. UV stability with scratch resistance increases exterior application durability. Silicone optics do not yellow, crack or brittle over time

CONTROL OPTIONS

CONTROL OPTIONS & FEATURES

- FSP-221 (FSP-X) - Passive infrared (PIR) sensor providing multi-level control based on motion/daylight contribution.
- All control parameters adjustable via wireless configuration remote storing and transmitting sensor profiles.
- * Party Setting Available (10% output) Consult Factory
- * Can maintain constant foot candles over time. Consult Factory
- FSP-20 mounting heights 9-20 feet
- FSP-40 mounting heights 21-40 feet.
- Includes 5 dimming event cycles, 0-10V dimming with motion sensing, re-programmable in the field. Programmable remote must be purchased separately.
- FSIR-100 commissioning remote is required to change sensor settings. Please contact factory for ordering.

- Controls Agnostic: Please contact factory for your preferred controls option. (nLight, NX, WaveLinX, Crestron, DMX/RDM, Synapse, Casambi, DALI II, Avi-On, or other control systems)

OPTIONS

- BIRD SPIKES (BS) - Offer an effective and humane deterrent for larger bird species and provide a cost-effective long-term solution to nuisance bird infestations and to protect your property.

- MARINE GRADE FINISH (MGF) - A multi-step process creating a protective finishing coat against harsh environments. Chemically washed in a 5-stage cleaning system. Pre-baked, Powder coated 3-5 mils of Zinc Rich Super Durable Polyester Primer. Oven Baked. Finished Powder Coating of Super Durable Polyester Powder Coat 3-5 mil thickness.

- House Side Shield (HSS) is designed for full property line cutoff.

FINISH

- 3-5 mils electrostatic powder coat.
- NLS Lighting standard high-quality finishes prevent corrosion, and protects against extreme environmental conditions.

WARRANTY

Five-year limited warranty for drivers and LEDs.
Consult Factory for 7 or 10 year warranty

LISTINGS

- Certified to UL 1598
- UL 8750
- CSA C22.2 No. 250.0
- IP66 Rated Fixture
- IP67 Rated Optics
- IK10 Rated

BUY AMERICAN OPTION

While all of the NLS Lighting products listed in this document qualify for the Buy America(n) Act of 1933, we reserve the right to change our listings without notice.

The information provided above is for general informational purposes only. We encourage you to consult legal professionals for advice particular to your projects concerning BAA, TAA, BABA or Buy America.

Additional NLS Products that meet BAA, TAA standards can be found at the following link:

<https://nslighting.com/buy-american/>



The information and specifications on this document are subject to change without any notification. All values are design, nominal, typical or prorated values when measured under internal and external laboratory conditions.

NLS
LIGHTING

701 Kingshill Place, Carson, CA 90746
Call Us Today (310) 341-2037

nslighting.com

PRODUCT SPECIFICATIONS

LUMEN CHART			
Part Number	T4	LM/W	WATTS
ORX-C-64L-425-27K7	6358	94	88
ORX-C-64L-425-27K8	5953	88	88
ORX-C-64L-425-30K8	6383	94	88
ORX-C-64L-425-30K7	6875	101	88
ORX-C-64L-425-35K8	6383	94	88
ORX-C-64L-425-40K8	6875	101	88
ORX-C-64L-425-40K7	7428	109	88
ORX-C-64L-425-50K8	6875	101	88
ORX-C-64L-425-50K7	7428	109	88
ORX-C-64L-530-27K7	9628	93	103
ORX-C-64L-530-27K8	9015	88	103
ORX-C-64L-530-30K8	9666	94	103
ORX-C-64L-530-30K7	10410	101	103
ORX-C-64L-530-35K8	9666	94	103
ORX-C-64L-530-40K8	10410	101	103
ORX-C-64L-530-40K7	11248	109	103
ORX-C-64L-530-50K8	10410	101	103
ORX-C-64L-530-50K7	11248	109	103
ORX-C-64L-600-27K7	10900	93	117
ORX-C-64L-600-27K8	10206	87	117
ORX-C-64L-600-30K8	10942	94	117
ORX-C-64L-600-30K7	11785	101	117
ORX-C-64L-600-35K8	10942	94	117
ORX-C-64L-600-40K8	11785	101	117
ORX-C-64L-600-40K7	12734	109	117
ORX-C-64L-600-50K8	11785	101	117
ORX-C-64L-600-50K7	12734	109	117
ORX-C-64L-700-27K7	12717	94	136
ORX-C-64L-700-27K8	11907	88	136
ORX-C-64L-700-30K8	12766	94	136
ORX-C-64L-700-30K7	13749	101	136
ORX-C-64L-700-35K8	12766	94	136
ORX-C-64L-700-40K8	13749	101	136
ORX-C-64L-700-40K7	14856	109	136
ORX-C-64L-700-50K8	13749	101	136
ORX-C-64L-700-50K7	14856	109	136
ORX-C-64L-850-27K7	14533	94	155
ORX-C-64L-850-27K8	13608	88	155
ORX-C-64L-850-30K8	14590	94	155
ORX-C-64L-850-30K7	15713	101	155
ORX-C-64L-850-35K8	14590	94	155
ORX-C-64L-850-40K8	15713	101	155
ORX-C-64L-850-40K7	16978	110	155
ORX-C-64L-850-50K8	15713	101	155
ORX-C-64L-850-50K7	16978	110	155

PRODUCT SPECIFICATIONS

MODEL	WIDTH	HEIGHT	DEPTH	WEIGHT
ORX-C	18"	3.1"	9"	11 LBS

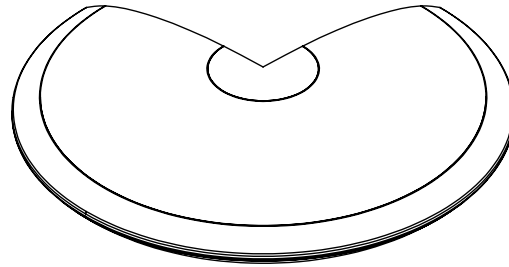
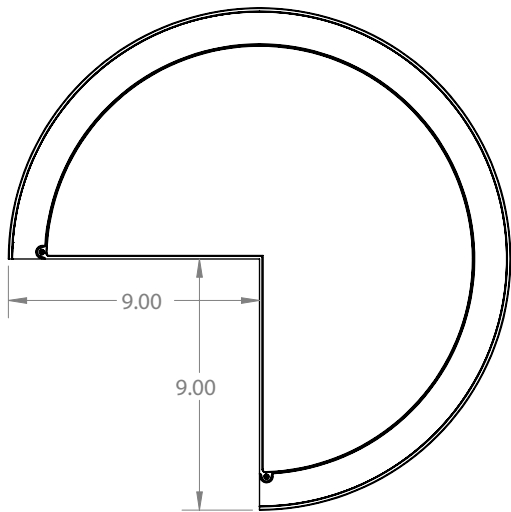
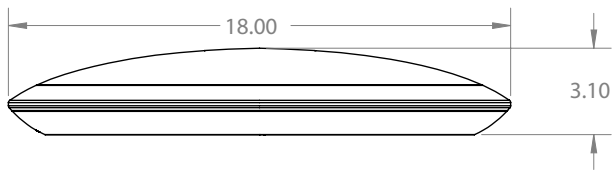

SCAN FOR INSTALLATION INSTRUCTIONS



SCAN FOR INSTALLATION INSTRUCTIONS



701 Kingshill Place, Carson, CA 90746
Call Us Today (310) 341-2037

nslighting.com

PRODUCT SPECIFICATIONS

FSP-211 WITH MOTION SENSOR (FSP-XX)

- FSP-211 (FSP-X)—Passive infrared (PIR) sensor providing multi-level control based on motion/daylight contribution.
- All control parameters adjustable via wireless configuration remote storing and transmitting sensor profiles.
- FSP-20 mounting heights 9-20 feet
- FSP-40 mounting heights 21-40 feet.
- Includes 5 dimming event cycles, 0-10V dimming with motion sensing, re-programmable in the field.
- FSIR-100 commissioning remote is required to change sensor settings. Please contact factory for ordering.

FSP-211

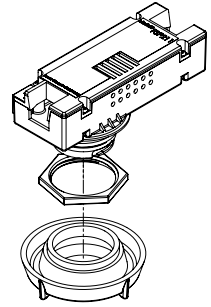

FSP-20

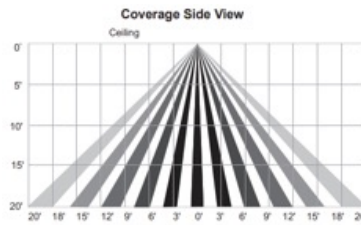
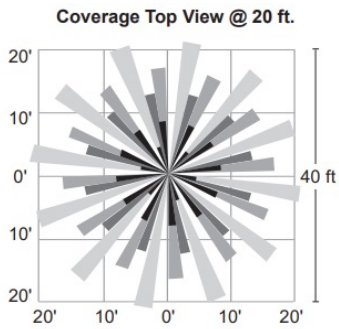

FSP-40

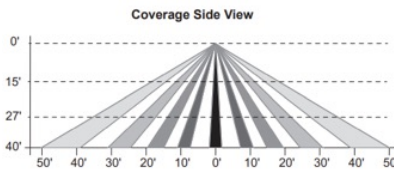
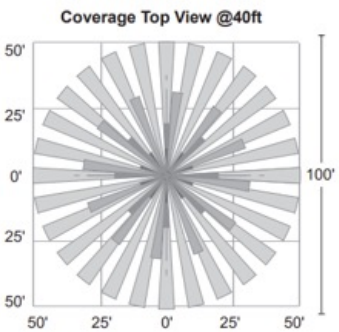

Sensor Specification



PRODUCT SPECIFICATIONS

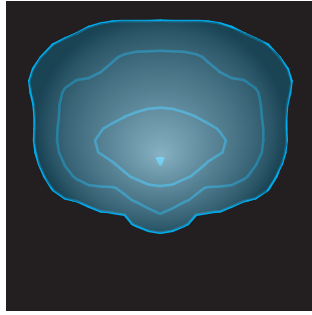
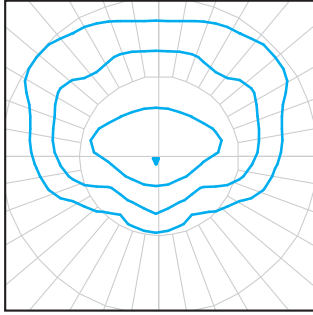

T4 Optic

The type IV distribution produces a semicircular light meant for mounting on the sides of buildings and walls. It's best for illuminating the perimeter of parking areas and businesses. The intensity of the Type IV lighting has the same intensity at angles from 90 degrees to 270 degrees.

Type IV light distributions have a preferred lateral width of 60 degrees. This distribution is intended for side-of-road mounting and is generally used on wide roadways where the roadway width does not exceed 3.7 times the mounting height.

SILICONE OPTICS

NLS Lighting Silicone Micro Optical System technology takes quality and performance to the highest level. Vandal resistant, superior clarity—Micro Optics have become the best and lasting solution in the industry.

BENEFITS

- Produces superior 96% clarity
- Heat resistant to 150° C, 50% higher than acrylic
- Ecologically friendly—no glare
- Vandal-resistant
- Does not brittle, crack, or yellow over time

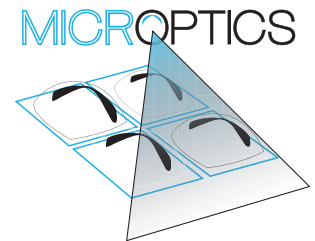

Lumen Maintenance Data							
Ambient Temperature	Drive Current	L90 Hours*	L70 Hours**	30,000 Hours*	50,000 Hours*	60,000 Hours*	100,000 Hours**
25°C	Up to 700mA	58,000	173,000	95.7%	91.6%	89.6%	82.1%
	850mA	48,000	143,000	94.3%	89.5%	87.2%	78.5%

*Reported extrapolations per IESNA TM-21 **Projected extrapolations per IESNA TM-21

LED KELVIN RANGE

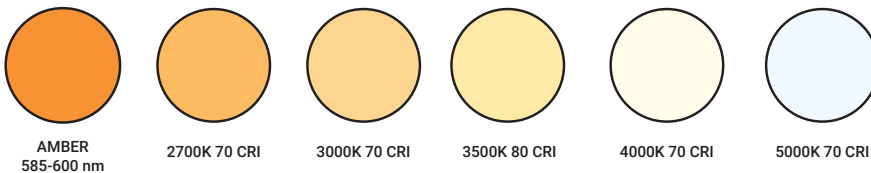

Color	Dominant or Peak Wavelength Range (nm)	
	Minimum	Maximum
Amber	585	600