



LED WATTAGE CHART

Drive Current	32L	64L
620 milliamps	60W (5711-7280 Lumens)	-
820 milliamps	80W (7305-9312 Lumens)	-
700 milliamps	-	139W (12397-15802 Lumens)
1000 milliamps	-	198W (18595-23703 Lumens)

**Form**

- Elegant Die-Cast Aluminum Housing
- Corrosion Resistant Stainless Steel External Hardware
- Sleek, Low Profile Housing
- Spec Grade Performance
- Engineered For Optimum Thermal Management
- 9 Architectural Finishes Standard, RAL Colors Available

**Function**

- Micro Optics IES Distributions 15°, 30°, 55°, 85°, T2, T3, T4, T5
- 0-10V Dimming Drivers THD @ Max Load < 15%
- Power factor @ Max Load < 0.95
- Amber, 2700K, 3000K, 3500K, 4000K, or 5000K
- 32L or 64L LED Configuration
- CRI 70, 80, or 90
- 5 Mils Powder Coat

**Reliability**

- Silicone Micro Optics
- 5 Year Standard Warranty
- IP67 Optics
- IP66 Fixture

**BUY AMERICAN**

To ensure the latest BAA/TAA/BABA Standards are being met, please select BAA, TAA, or BABA in the options section. Please contact the factory before placing an order for any NLS products requesting BAA (Buy American Act), TAA (Trade American Act), or BABA (Build America, Buy America).



Project Name:

Type:

# ORGANIX - F2 - ORDERING GUIDE

Cat#	Optics	Watts	Kelvin Temp		Volts
Organix - Flood <b>(ORX-F2)</b>	15° <b>(15)Ⓛ</b> <b>Very Narrow</b>	60W 32L <b>(60W)Ⓛ</b>	2700K, 80 CRI <b>(27K8)Ⓛ</b>	Red 624-634nm <b>(RED)Ⓛ</b>	120-277 <b>(UNV)</b>
	30° <b>(30)Ⓛ</b> <b>Narrow Beam</b>	80W 32L <b>(80W)Ⓛ</b>	3000K, 70 CRI <b>(30K7)</b>	Amber 585-600nm <b>(AMBER)Ⓛ ⑦</b>	347-480 <b>(HV)</b>
	55° <b>(55)</b> <b>Medium Beam</b>	139W 64L <b>(139W)</b>	3000K, 80 CRI <b>(30K8)Ⓛ</b>	Green 520-540nm <b>(GREEN)Ⓛ</b>	
	85° <b>(85)</b> <b>Wide Beam</b>	198W 64L <b>(198W)</b>	3500K, 80 CRI <b>(35K8)</b>	Royal Blue 440-460nm <b>(BLUE)Ⓛ</b>	
	IES T2 / <b>NEMA 7Hx5V</b> <b>(T2)Ⓛ</b>		4000K, 70 CRI <b>(40K7)</b>		
	IES T3 / <b>NEMA 7Hx6V</b> <b>(T3)Ⓛ</b>		4000K, 80 CRI <b>(40K8)Ⓛ</b>		
	Forward Throw <b>(T4)Ⓛ</b>		5000K, 70 CRI <b>(50K7)</b>		
	Symmetrical <b>(T5)</b>		5000K, 80 CRI <b>(50K8)Ⓛ</b>		

Mounting	Glare Control Options	Color	Controls Options	Options
Knuckle Mount 2 3/8" <b>(KM)</b>	Visor Accessory <b>(VR)</b>	Bronze Textured <b>(BRZ)</b>	Custom Controls Integration <b>(CCI)Ⓛ</b>	Tamper Proof Hardware <b>(TPH)</b>
Wall Mount <b>(WM)Ⓛ</b>	House Side Shield <b>(HSS)Ⓛ</b>	White Textured <b>(WHT)</b>		5 Conductor Dimming Leads <b>(DL)</b>
		Smooth White Gloss <b>(SWT)</b>		Marine Grade Finish <b>(MGF)</b>
		Silver Textured <b>(SVR)</b>		Black Hardware <b>(BH)Ⓛ</b>
		Black Textured <b>(BLK)</b>		Black Optic Frame <b>(BOF)Ⓛ</b>
		Smooth Black Gloss <b>(SBK)</b>		Buy American <b>(BAA)Ⓛ</b>
		Graphite Textured <b>(GPH)</b>		Trade American <b>(TAA)Ⓛ</b>
		Grey <b>(GRY)</b>		Build America Buy American <b>(BABA)Ⓛ</b>
		Green <b>(GRN)</b>		Diffused Polycarbonate Visual Comfort Lens <b>(DPCL)</b>
		Custom <b>(CS)</b>		Clear Tempered Glass Lens <b>(CTG)</b>

**Notes:**

- ① Static Colors Only. Consult Factory
- ② Consult Factory for Lead Time. Consult Factory for 90 CRI Requests.
- ③ House Side Shield for T2, T3, T4 only
- ④ Consult Factory for lead times
- ⑤ Wall Mount Bracket WM-SFA Required
- ⑥ Please contact Factory for Custom Control Integration requests (nLight, NX, WaveLinX, Crestron, DMX/RDM, Synapse, Casambi, Dali II, Avi-On, or other control systems)
- ⑦ Turtle Safe
- ⑧ Consult factory for all BAA/TAA/BABA requests
- ⑨ Not Available With Lens Options



701 Kingshill Place, Carson, CA 90746  
P: (310) 341-2037

nslighting.com

## PRODUCT SPECIFICATIONS

### ELECTRICAL

- 120-277 Volts (UNV) or 347-480 Volts (HV)
- 0-10V dimming driver
- Driver power factor at maximum load is  $\geq .95$ , THD maximum load is 15%
- LED Drivers Ambient Temp. Min is -40°C and Ambient Temp. Max ranges from 50°C to 55°C and, in some cases, even higher. Consult the factory for revalidation by providing the fixture catalog string before quoting and specifying it.
- All drivers, controls, and sensors housed in enclosed IP66 compartment
- CRI 70, 80 or 90
- Color temperatures: Amber, 2700K, 3000K, 3500K, 4000K, 5000K
- Surge Protection: 20KVA supplied as standard.

### CONSTRUCTION

- Die Cast Aluminum
- Internal cooling fins
- Corrosion resistant external hardware
- One-piece silicone gasket ensures IP66 seal for electronics compartment

### OPTICS

Silicone optics high thermal stability and light output provide higher powered LEDs with minimized lumen depreciation. UV stability with scratch resistance increases exterior application durability. Silicone optics do not yellow, crack or brittle over time

### CONTROL OPTIONS

- Controls Agnostic: Please contact factory for your preferred controls option. (nLight, NX, WaveLinx, Crestron, DMX/RDM, Synapse, Casambi, DALI II, Avi-On, or other control systems)

### OPTIONS

- TAMPER PROOF HARDWARE - Provided to protect the optical assembly and the driver compartment for vandal resistance.
- 5 CONDUCTOR DIMMING LEADS—Standard Dimming Leads exiting the fixture for external dimming control.
- MARINE GRADE FINISH (MGF) - A multi-step process creating protective finishing coat against harsh environments.
  - Chemically washed in a 5 stage cleaning system.
  - Pre-baked
  - Powder coated 3-5 mils of Zinc Rich Super Durable Polyester Primer.
  - Oven Baked.
  - Finished Powder Coating of Super Durable Polyester Powder Coat 3-5 mil thickness.
- BLACK HARDWARE (BH) - Optional black, zinc coated steel hardware.
- BLACK OPTIC FRAME (BOF) - Optional black optic frame. Standard is white.

### FINISH

- 3-5 mils electrostatic powder coat.
- NLS Lighting standard high-quality finishes prevent corrosion, and protects against extreme environmental conditions.

### WARRANTY

Five-year limited warranty for drivers and LEDs. Consult Factory for 7 or 10 year warranty

### LISTINGS

- Certified to UL 1598
- UL 8750
- CSA C22.2 No. 250.0
- IP66 Rated Fixture
- IP67 Rated Optics
- IK10 Rated

### BUY AMERICAN OPTION

While all of the NLS Lighting products listed in this document qualify for the Buy America(n) Act of 1933, we reserve the right to change our listings without notice.

The information provided above is for general informational purposes only. We encourage you to consult legal professionals for advice particular to your projects concerning BAA, TAA, BABA or Buy America.

Additional NLS Products that meet BAA, TAA standards can be found at the following link:

<https://nslighting.com/buy-american/>



The information and specifications on this document are subject to change without any notification. All values are design, nominal, typical or prorated values when measured under internal and external laboratory conditions.

**NLS**  
LIGHTING

701 Kingshill Place, Carson, CA 90746  
Call Us Today (310) 341-2037

[nslighting.com](http://nslighting.com)

# PRODUCT SPECIFICATIONS

Part Number	LUMEN CHART								WATTS
	15°	LM/W	30°	LM/W	55°	LM/W	85°	LM/W	
ORX-F2-32L-620-27K7	5711	95	5781	96	6018	100	6232	104	60
ORX-F2-32L-620-27K8	5348	89	5412	90	5635	94	5835	97	60
ORX-F2-32L-620-30K8	5733	96	5803	97	6041	101	6256	104	60
ORX-F2-32L-620-30K7	6175	103	6250	104	6506	108	6738	112	60
ORX-F2-32L-620-35K8	5733	96	5803	97	6041	101	6256	104	60
ORX-F2-32L-620-40K8	6175	103	6250	104	6506	108	6738	112	60
ORX-F2-32L-620-40K7	6672	111	6753	113	7030	117	7280	121	60
ORX-F2-32L-620-50K8	6175	103	6250	104	6506	108	6738	112	60
ORX-F2-32L-620-50K7	6672	111	6753	113	7030	117	7280	121	60
ORX-F2-32L-820-27K7	7305	91	7394	92	7697	96	7971	100	80
ORX-F2-32L-820-27K8	6840	85	6923	87	7207	90	7464	93	80
ORX-F2-32L-820-30K8	7333	92	7423	93	7727	97	8002	100	80
ORX-F2-32L-820-30K7	7898	99	7994	100	8322	104	8618	108	80
ORX-F2-32L-820-35K8	7333	92	7423	93	7727	97	8002	100	80
ORX-F2-32L-820-40K8	7898	99	7994	100	8322	104	8618	108	80
ORX-F2-32L-820-40K7	8534	107	8638	108	8992	112	9312	116	80
ORX-F2-32L-820-50K8	7898	99	7994	100	8322	104	8618	108	80
ORX-F2-32L-820-50K7	8534	107	8638	108	8992	112	9312	116	80
ORX-F2-64L-700-27K7	12397	89	12548	90	13062	94	13526	97	139
ORX-F2-64L-700-27K8	11607	84	11749	85	12230	88	12665	91	139
ORX-F2-64L-700-30K8	12445	90	12597	91	13113	94	13579	98	139
ORX-F2-64L-700-30K7	13403	96	13567	98	14123	102	14625	105	139
ORX-F2-64L-700-35K8	12445	90	12597	91	13113	94	13579	98	139
ORX-F2-64L-700-40K8	13403	96	13567	98	14123	102	14625	105	139
ORX-F2-64L-700-40K7	14482	104	14659	105	15259	110	15802	114	139
ORX-F2-64L-700-50K8	13403	96	13567	98	14123	102	14625	105	139
ORX-F2-64L-700-50K7	14482	104	14659	105	15259	110	15802	114	139
ORX-F2-64L-1A-27K7	18595	94	18822	95	19593	99	20290	102	198
ORX-F2-64L-1A-27K8	17411	88	17623	89	18345	93	18998	96	198
ORX-F2-64L-1A-30K8	18667	94	18895	95	19669	99	20369	103	198
ORX-F2-64L-1A-30K7	20105	102	20350	103	21184	107	21937	111	198
ORX-F2-64L-1A-35K8	18667	94	18895	95	19669	99	20369	103	198
ORX-F2-64L-1A-40K8	20105	102	20350	103	21184	107	21937	111	198
ORX-F2-64L-1A-40K7	21723	110	21988	111	22889	116	23703	120	198
ORX-F2-64L-1A-50K8	20105	102	20350	103	21184	107	21937	111	198
ORX-F2-64L-1A-50K7	21723	110	21988	111	22889	116	23703	120	198



701 Kingshill Place, Carson, CA 90746  
Call Us Today (310) 341-2037

[nslighting.com](http://nslighting.com)

# PRODUCT SPECIFICATIONS

MODEL	WIDTH	HEIGHT	WEIGHT
ORX-F2	18"	3.15"	17 LBS

EPA	ORX-F2
	.22ft <sup>2</sup>

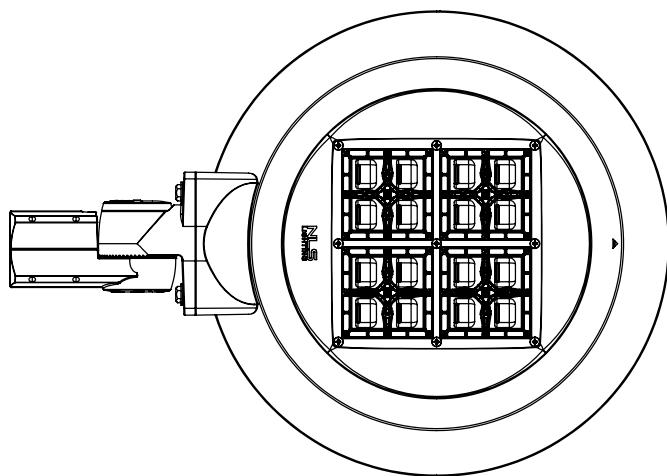
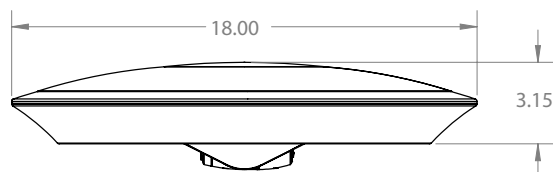
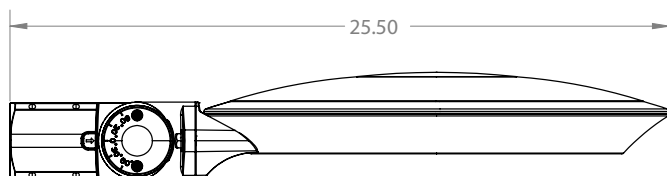

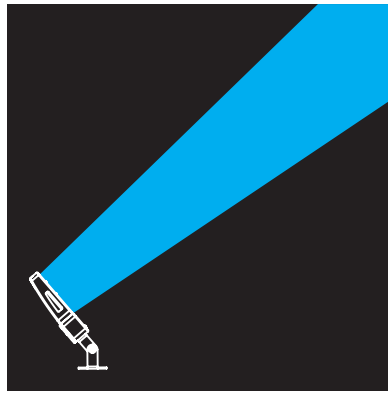
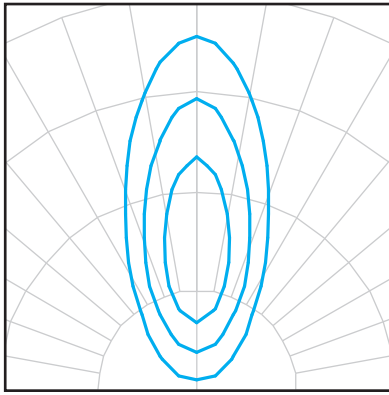

### 15° Very Narrow Beam Optic

The 15° Optic is used for very specific spot lighting. Spot Lighting a statue, a monument, or a piece of art. The NV Floods can be used indoors and outdoors. Pair the 15° Optic with the following Glare Control Options for more dramatic effect. Snoot Short (SNS), Snoot Long (SNL), or Egg Crate Louvers (ECL). These Glare Control Options help reduce glare and focus the viewing angles.

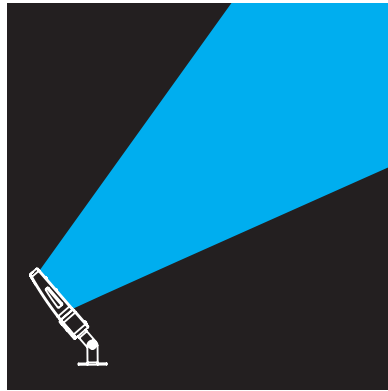
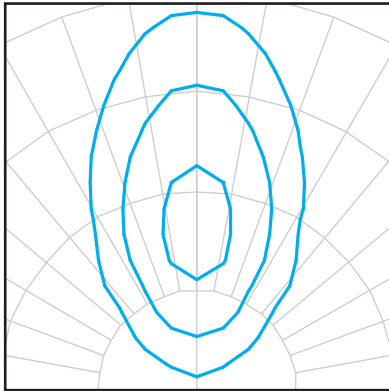

### 30° Narrow Beam Optic

The 30° Optic is used for larger objects and for spot and accent lighting. The 30° is perfect for Flag Lighting, Facade Lighting and great for showcasing Car Dealerships, display pads. Pair the 30° Optic with the following Glare Control Options for more dramatic effect. Snoot Short (SNS), Snoot Long (SNL), or Egg Crate Louvers (ECL). These Glare Control Options help reduce glare and focus the viewing angle.

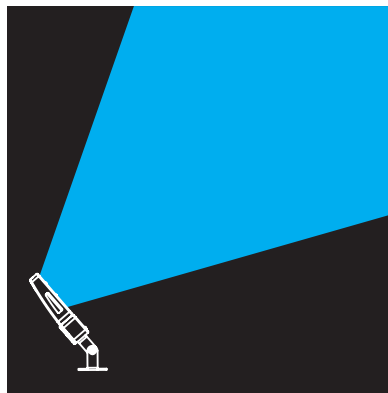
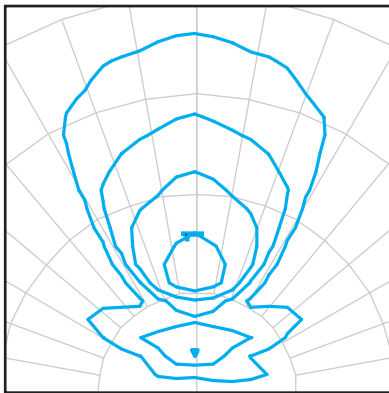

### 55° Medium Beam Optic

The 55° Optic is used for larger objects, flood lighting. The 55° is perfect for Facade Lighting, Landscape and general flood lighting. Pair the 55° Optic with the following Glare Control Options for more dramatic effect. Snoot Short (SNS), Angled Visor (AGV), These Glare Control Options help reduce glare and focus the beam angles.

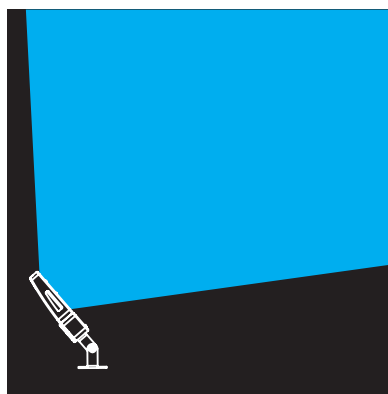
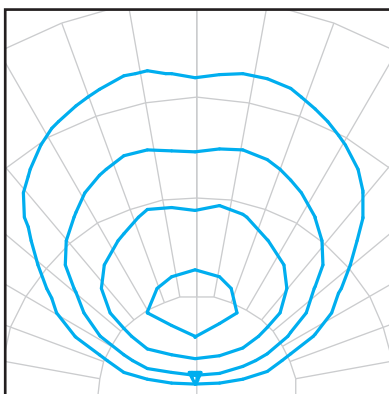

### 85° Wide Flood Optic

The 85° Optic is used for large area and accent lighting. The 85° is perfect for Security Lighting, general flood lighting and area lighting. Pair the 85° Optic with the following Glare Control Options for more dramatic effect. Snoot Small (SNS), Angled Visor (AGV), These Glare Control Options help reduce glare and shield unnecessary light.

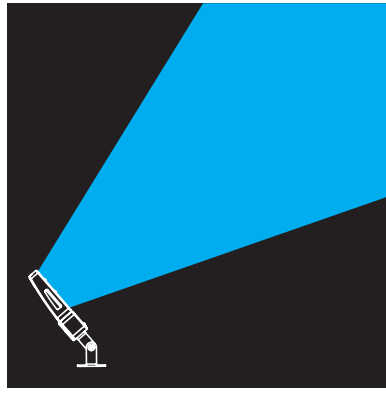
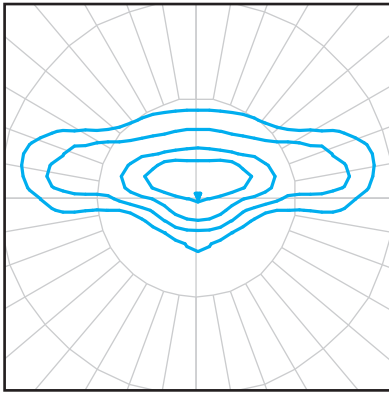

### NEMA 7X5 T2 Flood Optic

The Type II (T2) distribution is used for narrow pathways and trails, narrow entrances of shopping centers, parking lots and office complex's.

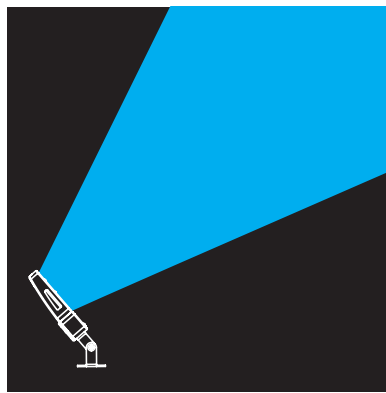
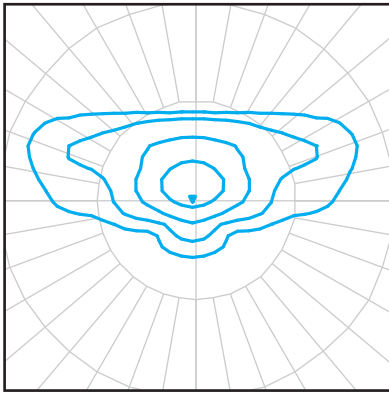

### NEMA 7X6 T3 Flood Optic

The Type III (T3) distribution is meant for roadway lighting, general parking areas and other areas where a larger area of lighting is required. Type III lighting needs to be placed to the side of the area, allowing the light to project outward and fill the area. This produces a filling light flow.

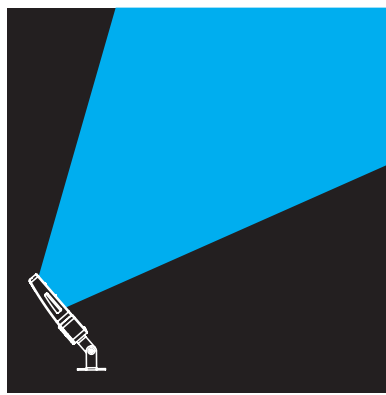
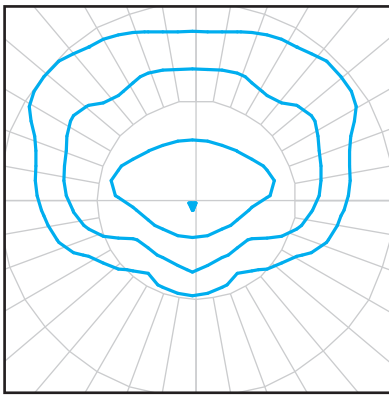

### NEMA 6X6 Forward Throw T4 Flood Optic

The Type IV (T4) distribution produces a semicircular light meant for mounting on the sides of buildings and walls. It is best for illuminating the perimeter of parking areas and businesses. The intensity of the Type IV lighting has the same intensity at angles from 90° to 270°.

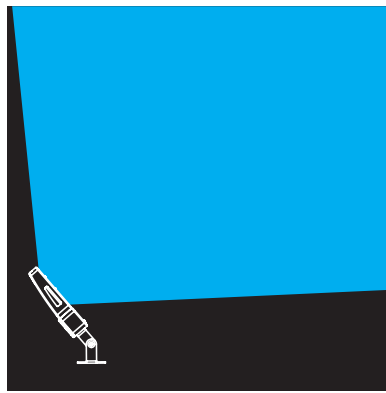
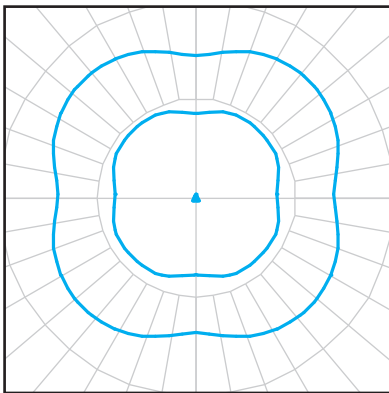

### NEMA 7X7 Symmetrical T5 Flood Optic

The Type V (T5) produces a symmetrical distribution that has the same intensity at all angles. This distribution has a uniform symmetry of candlepower that is essentially the same at all lateral angles. It is meant for large, commercial parking lot lighting as well as areas where sufficient, evenly distributed light is necessary

# PRODUCT SPECIFICATIONS

Lumen Maintenance Data							
Ambient Temperature	Drive Current	L90 Hours*	L70 Hours**	30,000 Hours*	50,000 Hours*	60,000 Hours*	100,000 Hours**
25°C	Up to 700mA	58,000	173,000	95.7%	91.6%	89.6%	82.1%
	1000mA	48,000	143,000	94.3%	89.5%	87.2%	78.5%

\*Reported extrapolations per IESNA TM-21      \*\*Projected extrapolations per IESNA TM-21

## LED KELVIN RANGE

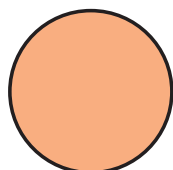

2700K 80 CRI

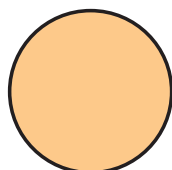

3000K 70 CRI

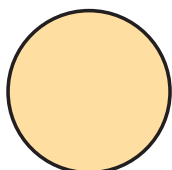

3500K 80 CRI

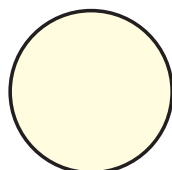

4000K 70 CRI

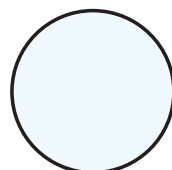

5000K 70 CRI

## STATIC COLOR LED

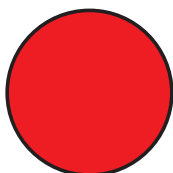

RED  
624-634 nm

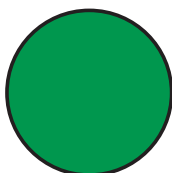

GREEN  
520-540 nm

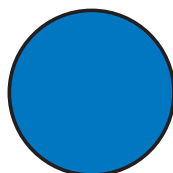

ROYAL BLUE  
440-460nm

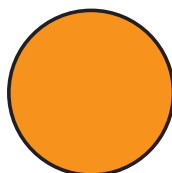

AMBER  
585-600 nm

Color	Dominant or Peak Wavelength Range (nm)	
	Minimum	Maximum
Amber	585	600



**VISOR ACCESSORY (VR)**

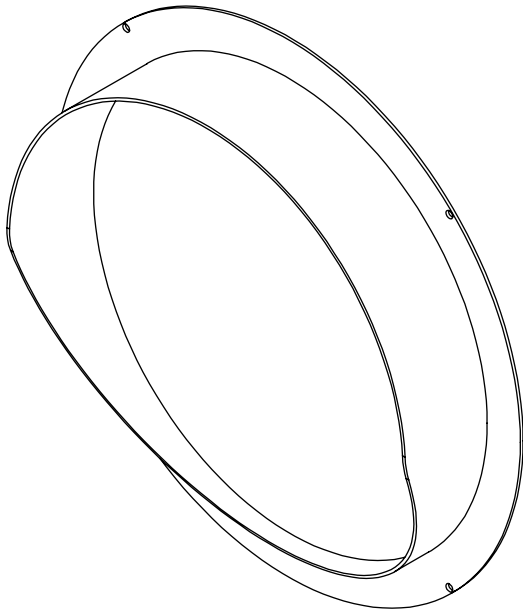

**VISOR ACCESSORY (VR)**

Visor Accessory cut off precision spot lighting. Laser cut precision formed aluminum construction. Powder Coated flat black as standard.

**HOUSE SIDE SHIELD (HSS)**

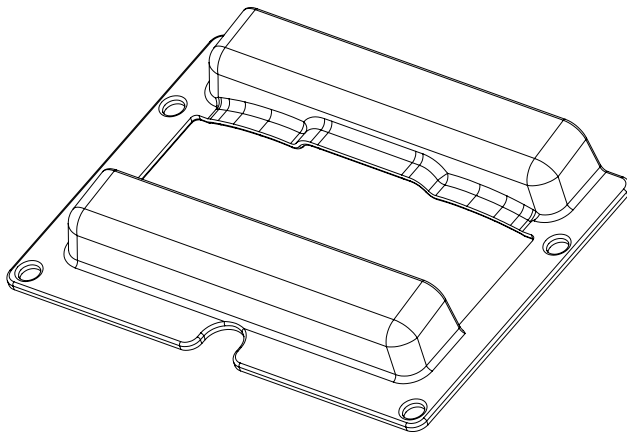

**House Side Shield (HSS)**

House Side Shield (**HSS**) is designed for stringent property line cutoff. Injection Molded Glass Filled Nylon, standard finish is black.

**MARINE GRADE FINISH**

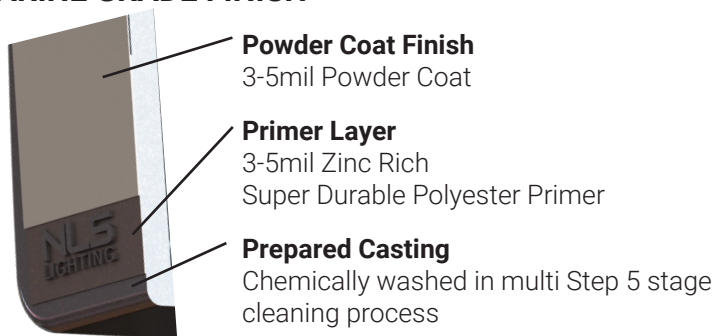

**Marine Grade Finish (MGF)**

The **(MGF)** is a multi step process. Chemically washed in a 5 stage cleaning system. Pre-baked. Powder coated 3-5 mils of Zinc Rich Super Durable Polyester Primer. Oven Baked. Finished Powder Coating of Super Durable Polyester Powder Coat 3-5 mil thickness.

**5 CONDUCTOR DIMMING LEADS**

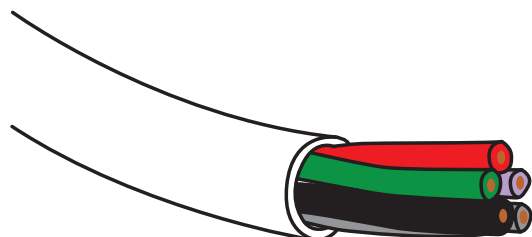

**5 Conductor Dimming Leads (DL)**

Standard Dimming Leads exiting the fixture for external dimming control.

**TAMPER PROOF HARDWARE**

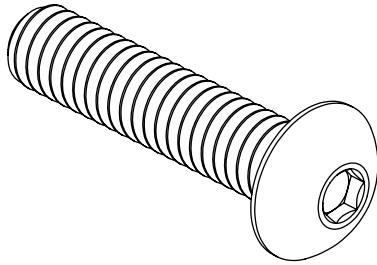

**Tamper Proof Hardware (TPH)**

316 Stainless Steel Button Head Hex Drive Screws. Provided to protect the optical assembly and the driver compartment for vandal resistance.

**BLACK HARDWARE**

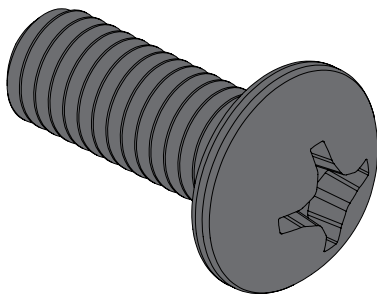

**Black Hardware (BH)**

Black painted hardware.

**BLACK OPTIC FRAME**

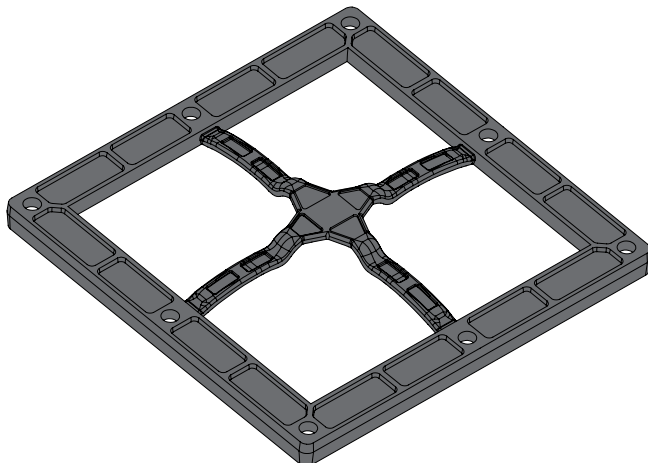

**Black Optic Frame (BOF)**

Optional Black Optic Frame.

**KNUCKLE MOUNT 2 3/8" (KM)**

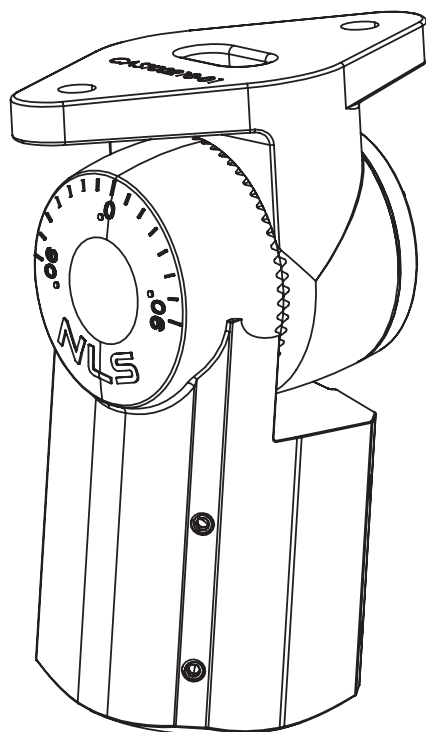

**(KM)** Knuckle Mount fits over a 2-3/8" Tenon. Max tilt 180°.