

FORM AND FUNCTION

- Sleek, low profile housing
- Engineered for optimum thermal management
- Low depreciation rate
- Optical system designed for:
 - Parking Lots
 - Commercial Applications

CONSTRUCTION

- Die Formed heavy duty Aluminum
- Corrosion resistant external hardware
- One-piece silicone gasket ensures IP-65 seal for electronics compartment
- Two-piece silicone Micro Optic system ensures IP-67 level seal around each PCB

BUY AMERICAN

To ensure the latest BAA/TAA/BABA Standards are being met, please select BAA, TAA, or BABA in the options section. Please contact the factory before placing an order for any NLS products requesting BAA (Buy American Act), TAA (Trade American Act), or BABA (Build America, Buy America).



LED WATTAGE CHART

	80L	96L
1050 milliamps	263w	316w

Project Name:						Type:	

Cat#	Light Dist.	# of LEDs	Milliamps	Kelvin	Volts	Mounting	Color	Options
Value Series Round 2 (VSR-2)	Type 2 (T2)	80 (80L)	1050 (1)	Amber 585-600nm (AMBER) ① ⑦	120-277 (UNV)	Direct Pole 6" Arm Single, D180 (DPS6) ②	Bronze Textured (BRZ)	Bird Spikes (BS) Marine Grade Finish (MGF) Button Photocell (PC) ④ Nema 7-Pin Receptacle (PE7) Photocell + Receptacle (PCR) Receptacle + Shorting Cap (PER) FSP-211 with Motion Sensor (FSP-8) ⑤ 8'+ Below (FSP-20) ⑤ 9'-20' Heights (FSP-40) ⑤ 21'-40' Heights Quick Mount Bracket (QMB) Retrofit Mount Bracket (RQMB) Round Pole Adaptor 3"- 4" Pole (RPA4) Round Pole Adaptor 5"- 6" Pole (RPA5) Rotated Optic Left (ROL) Rotated Optic Right (ROR) Automotive House Side Shield (AHS) House Side Shield (HSS) Buy American (BAA) ⑧ Trade American (TAA) ⑧ Build America Buy American (BABA) ⑧ Custom Controls Integration (CCI) ⑧
	Type 3 (T3)	96 (96L)		2700K, 70 CRI (27K7) ⑤	347-480 (HV)	Direct Pole 10" Arm D90, T90, T120, Quad (DPS10) ②	White Textured (WHT)	
	Type 4 (T4)			2700K, 80 CRI (27K8) ① ⑤		Wall Mount (WM) ③	Smooth White Gloss (SWT)	
	Type 5 (T5)			3000K, 70 CRI (30K7) ⑤			Silver (SVR)	
				3000K, 80 CRI (30K8) ① ⑤			Black Textured (BLK)	
		3500K, 80 CRI (35K8)				Smooth Black Gloss (SBK)		
		4000K, 70 CRI (40K7)				Graphite Textured (GPH)		
		4000K, 80 CRI (40K8) ①				Grey Textured (GRY)		
		5000K, 70 CRI (50K7)				Custom (CS)		
		5000K, 80 CRI (50K8) ①						

Notes:

- ① Consult Factory for Lead Time. Consult Factory for 90 CRI Requests.
- ② For Round Pole Specify RPA4 or RPA5
- ③ Includes 6" Bolt On Arm
- ④ Universal Voltage 120-277
- ⑤ 3000K or lower must be selected to meet International Dark Sky Association certification
- ⑥ Please contact Factory for Custom Control Integration requests (nLight, NX, WaveLinX, Crestron, DMX/RDM, Synapse, Casambi, Dali II, Avi-On, or other control systems)
- ⑦ Turtle Safe
- ⑧ Consult factory for all BAA/TAA/BABA requests

PRODUCT SPECIFICATIONS

ELECTRICAL

- 120-277 Volts (UNV) or 347-480 Volts (HV)
- 0-10V dimming driver
- Driver power factor at maximum load is $\geq .95$, THD maximum load is 15%
- LED Drivers Ambient Temp. Min is -40°C and Ambient Temp. Max ranges from 50°C to 55°C and, in some cases, even higher. Consult the factory for revalidation by providing the fixture catalog string before quoting and specifying it.
- All internal wiring UL certified for 600 VAC and 105°C
- All drivers, controls, and sensors housed in enclosed IP-65 compartment
- CRI 70, 80 or 90
- Color temperatures: Amber, 2700K, 3000K, 3500K, 4000K, 5000K
- Surge Protection: 20KA supplies as standard.

OPTIONS

- **BIRD SPIKES (BS)**—Offers effective and humane deterrent for larger bird species and provides cost-effective long-term solution to nuisance bird infestations and protect your property.
- **MARINE GRADE FINISH (MGF)**—A multi-step process creating protective finishing coat against harsh environments.
 - Chemically washed in a 5 stage cleaning system.
 - Pre-baked
 - Powder coated 3-5 mils of Zinc Rich Super Durable Polyester Primer.
 - 1-2 feet inside pole coverage top and bottom.
 - Oven Baked.
 - Finished Powder Coating of Super Durable Polyester Powder Coat 3-5 mil thickness.
- **SHIELDS (HSS, AHS)**—House Side Shield (HSS) is designed for full property line cut-off. Automotive House Side Shield (AHS) is a single-sided shield allowing partial cut-off on either side or front of luminaire.
- **ROUND POLE ADAPTER (RPA)**— When using round poles, specify Round Pole Adapter (RPA). Specify RPA4 when installing on 3"-4" round poles, and RPA5 when installing on 5"-6" round poles.

CONTROLS

- **FSP-211 (FSP-X)**—Passive infrared (PIR) sensor providing multi-level control based on motion/daylight contribution.
 - All control parameters adjustable via wireless configuration remote storing and transmitting sensor profiles.
 - FSP-20 mounting heights 9-20 feet
 - FSP-40 mounting heights 21-40 feet.
 - Includes 5 dimming event cycles, 0-10V dimming with motion sensing, re-programmable in the field.
 - FSIR-100 commissioning remote is required to change sensor settings. Please contact factory for ordering.
- **NEMA 7-PIN RECEPTACLE (PE7)**—An ANSI C136.41-2013 receptacle provides electrical and mechanical interconnection between photo control cell and luminaire. Dimming receptacle available two or four dimming contacts supports 0-10 VDC dimming methods or Digital Addressable Lighting Interface (DALI), providing reliable power interconnect.
- Controls Agnostic: Please contact factory for your preferred controls option. (nLight, NX, WaveLinx, Crestron, DMX/RDM, Synapse, Casambi, DALI II, Avi-On, or other control systems)

OPTICS

Silicone optics high photothermal stability and light output provides higher powered LEDs with minimized lumen depreciation LED life. UV and thermal stability with scratch resistance increases exterior application durability.

- IES Types

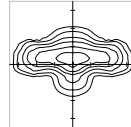

TYPE II (T2)

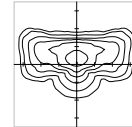

TYPE III (T3)

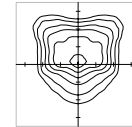

TYPE IV (T4)

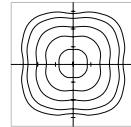

TYPE V (T5)

FINISH

- 5 mils electrostatic powder coat.
- NLS' standard high-quality finishes prevent corrosion protects against extreme environmental conditions

WARRANTY

Five-year limited warranty for drivers and LEDs.

LISTINGS

- Certified to UL 1598
- CSA C22.2 No. 250.0
- IP65/ IP67 Rated
- Dark Sky Approved
- IK10 Rated

BUY AMERICAN OPTION

While all of the NLS Lighting products listed in this document qualify for the Buy America(n) Act of 1933, we reserve the right to change our listings without notice.

The information provided above is for general informational purposes only. We encourage you to consult legal professionals for advice particular to your projects concerning BAA, TAA, BABA or Buy America.

Additional NLS Products that meet BAA, TAA standards can be found at the following link:

<https://nslighting.com/buy-american/>



The information and specifications on this document are subject to change without any notification. All values are design, nominal, typical or prorated values when measured under internal and external laboratory conditions.

NLS
LIGHTING

701 Kingshill Place, Carson, CA 90746
Call Us Today (310) 341-2037

nslighting.com

PRODUCT SPECIFICATIONS

LUMENS

PART NUMBER	T2	LM/W	BUG	T3 HSS	LM/W	BUG	T3	LM/W	BUG	T4 AHS	LM/W	T4 HSS	LM/W	BUG	T4	LM/W	BUG	T5	LM/W	BUG	Watts
VSR-2-80L-1-30K7	27510	105	B3-U0-G3	15254	58	B1-U0-G3	26826	102	B3-U0-G4	18936	72	14991	57	B1-U0-G3	26585	101	B3-U0-G4	27741	105	B5-U0-G4	263
VSR-2-80L-1-40K7	29601	113	B3-U0-G3	16306	62	B1-U0-G3	28865	110	B3-U0-G4	19988	76	16043	61	B1-U0-G3	28606	109	B3-U0-G4	29850	113	B5-U0-G4	263
VSR-2-80L-1-50K7	30261	115	B3-U0-G3	17358	66	B1-U0-G3	29509	112	B3-U0-G4	21040	80	17095	65	B1-U0-G3	29244	111	B3-U0-G4	30515	116	B5-U0-G4	263
VSR-2-96L-1-30K7	33054	105	B3-U0-G4	18328	58	B1-U0-G3	32232	102	B3-U0-G4	22752	72	18012	57	B1-U0-G3	31943	101	B3-U0-G4	33332	105	B5-U0-G4	316
VSR-2-96L-1-40K7	35566	113	B3-U0-G4	19592	62	B1-U0-G3	34682	110	B4-U0-G4	24016	76	19276	61	B1-U0-G4	34371	109	B3-U0-G4	35865	113	B5-U0-G4	316
VSR-2-96L-1-50K7	36359	115	B4-U0-G4	20856	66	B1-U0-G4	35455	112	B4-U0-G4	25280	80	20540	65	B1-U0-G4	35137	111	B3-U0-G4	36665	116	B5-U0-G4	316

Lumen Maintenance Data

Ambient Temperature	Drive Current	L90 Hours*	L70 Hours**	30,000 Hours*	50,000 Hours*	60,000 Hours*	100,000 Hours**
25°C	1050mA	38,000	96,000	93.0%	85.4%	81.8%	68.8%

*Reported extrapolations per IESNA TM-21 **Projected extrapolations per IESNA TM-21

LED KELVIN RANGE

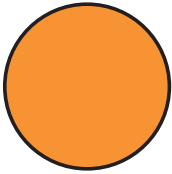

AMBER
585-600 nm

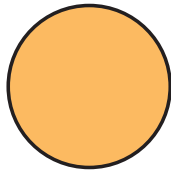

2700K 70 CRI

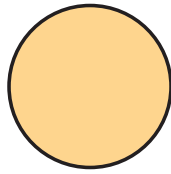

3000K 70 CRI

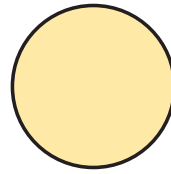

3500K 80 CRI

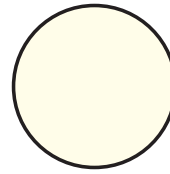

4000K 70 CRI

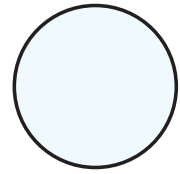

5000K 70 CRI

Color	Dominant or Peak Wavelength Range (nm)	
	Minimum	Maximum
Amber	585	600







PRODUCT SPECIFICATIONS

DIMENSION	VSR-2
A	21.5
B	6.5
Weight	26lbs

EPA

EPA	SGL	D90	D180	T90	T120	QD
VSR-2	1.36	2.17	2.73	3.18	2.91	3.18

DPX ARM LENGTH

DPX ARM LENGTH	SGL 	D90 	D180 	T90 	T120 	QD 
VSR-2	6"	10"	6"	10"	10"	10"

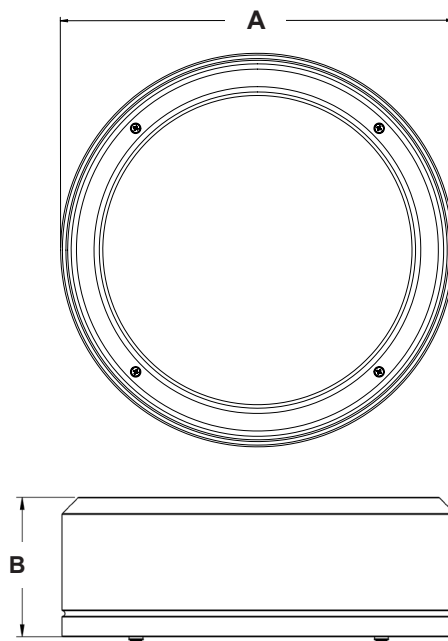

OPTICAL CONFIGURATIONS

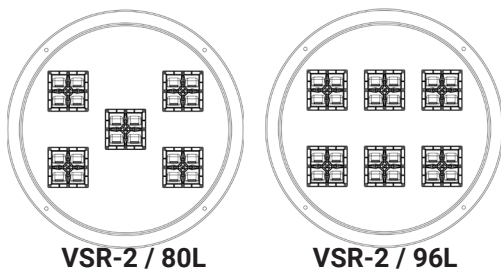

PRODUCT SPECIFICATIONS

DIRECT POLE MOUNT(DPX)

Standard mounting arm is extruded aluminum in lengths of 6" and 10"

*Arm lengths may vary depending on configuration

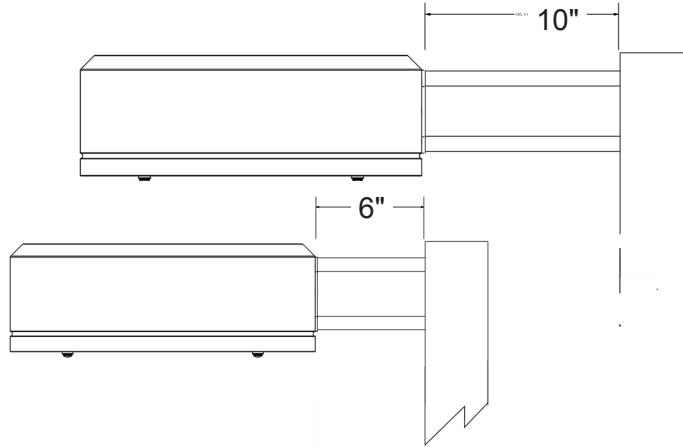

WALL MOUNT (WM)

Cast Aluminum Plate for direct wall mount.
3" extruded aluminum arm mounts directly to a cast wall mount box.

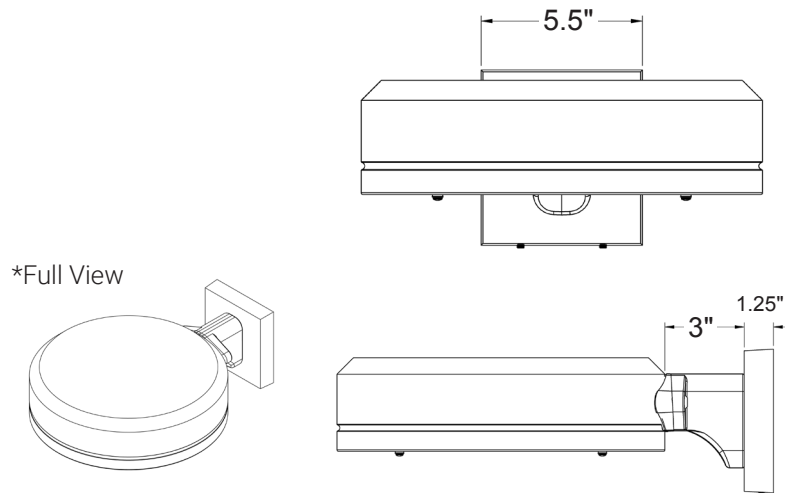

PRODUCT SPECIFICATIONS

Optional Cast Aluminum Bracket designed for quick mounting on Direct Square or Round Poles. Cleat mounts directly to pole for easily hung fixtures.

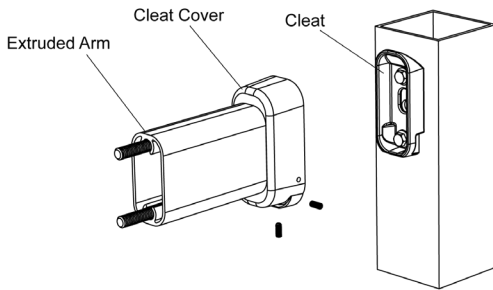

**QUICK MOUNT BRACKET (QMB)
DIRECT POLE (DP6/DP10)**

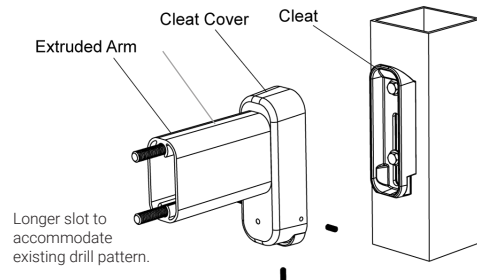
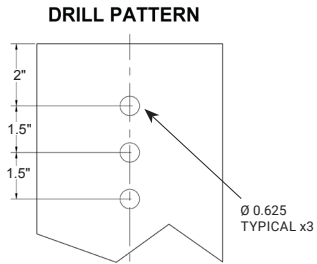

RETROFIT QUICK MOUNT BRACKET (RQMB)

RQMB DRILL PATTERN

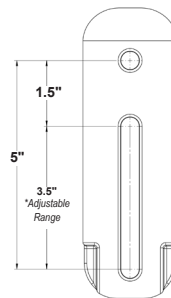

HOUSE SIDE SHIELD

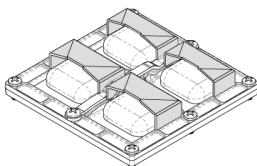

AUTOMOTIVE HOUSE SIDE SHIELD

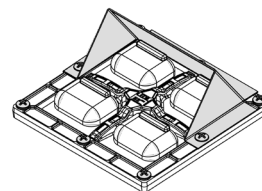

RPA4 / RPA5

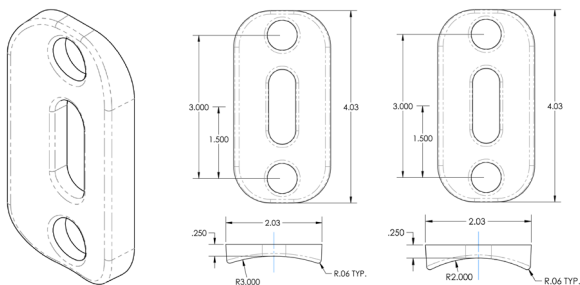

FSP-211

